

Assembly Instructions - Mantis 2

**** You must have the monitor on to make the arm move properly.
Do not adjust tension until you have the monitor on the unit first.**

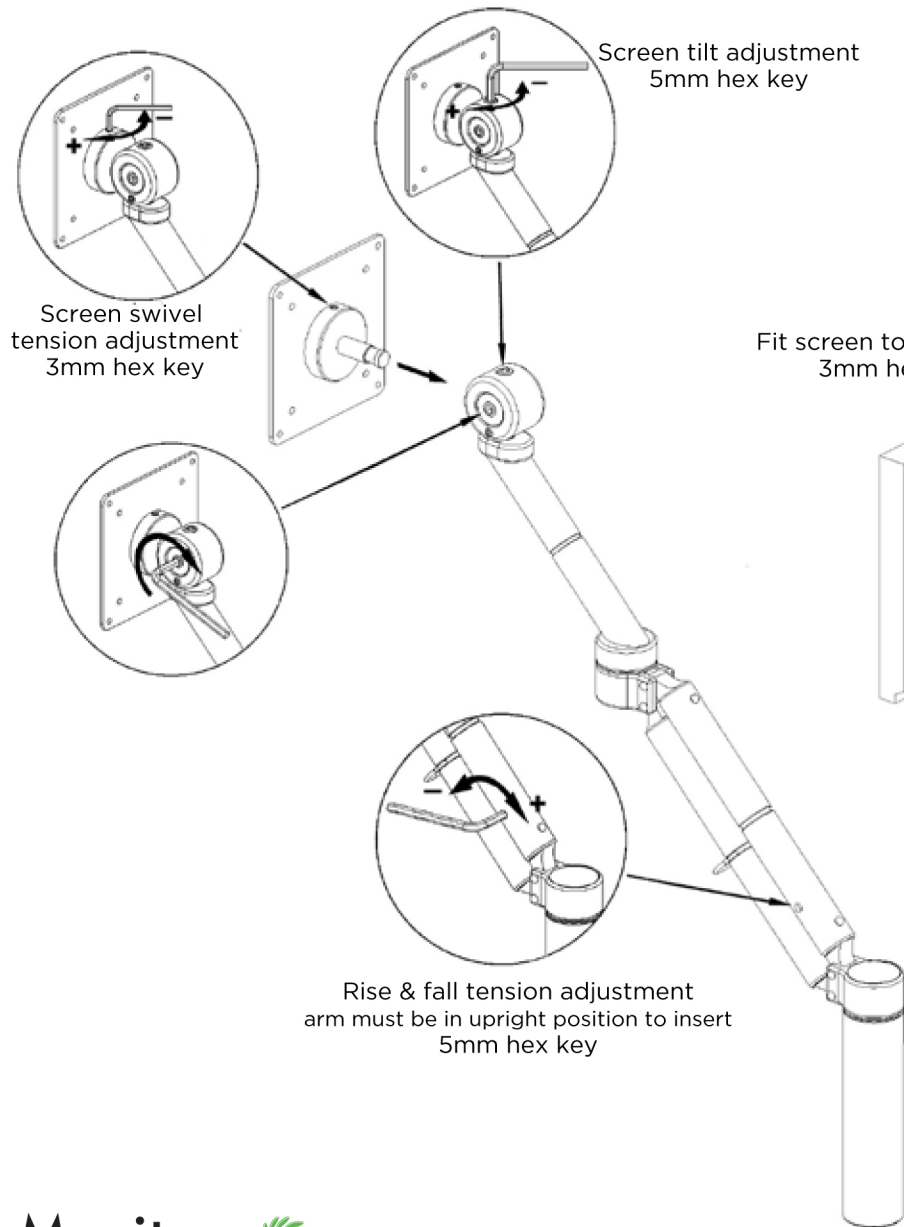

Instructions:

1. Use the edge clamp, through desk mount or the Vice clamp to attach the arm to the surface.
2. Attach screen to VESA plate mounting using a 3mm hex key.
3. Insert Vesa plate to arm.
4. Adjust screen tilt, screen swivel and rise & fall tension.
(Please do not over-tighten)

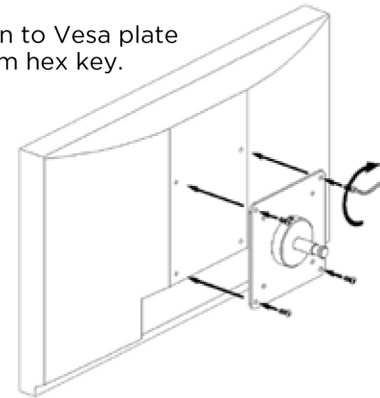

Tools Required:

- 8mm Hex key (supplied)
- 5mm Hex key (supplied)
- 3mm Hex key (supplied)

- 19 mm wrench
(through desk/cable grommet)
(customer supplied)

Post fitting options

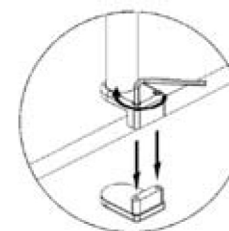

Vice clamp
5mm Hex key
+8mm hex key & 12mm bolt

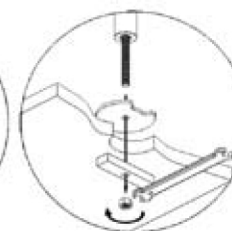

Cable grommet
19mm Wrench

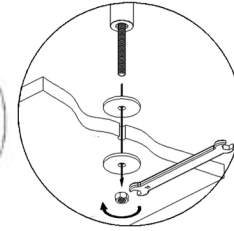

Through desk
19mm Wrench